

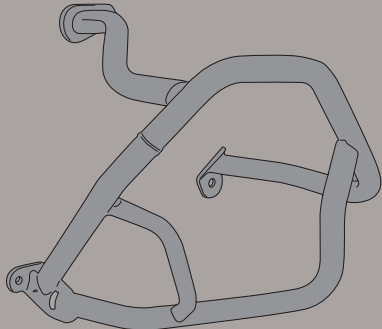

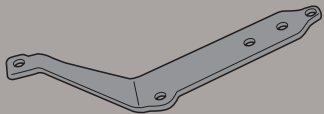
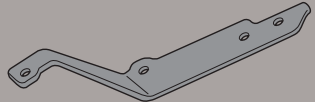

TN5108 - KN5108 SPECIFIKUS BUKÓCSŐ

BMW R1200GS (2013)

N°	Megnevezés	Méret	Kód	Mennyiség	
1	Bukócső	-	-	2 (Dx;Sx)	
2	Rögzítőelem	Sp. 5mm (Dx)	GL2413	1	
3	Rögzítőelem	Sp. 5mm (Sx)	GL2414	1	
4	Csavar	TCEI M10x50	1050TCEI	4	
5	Csavar	TECEI M10x30	1030TCEI	2	
6	Csavar	TCEI M8x25	825TCEI	6	
7	Csavar	TCEI M8x20	820TCEI	2	
8	Feszítőhüvely	Ø33x22 furat 28mm	LT0979	2	
9	Távtartó	Ø29.5/Ø26.5 furat M10	V866	2	

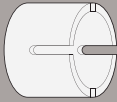
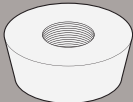
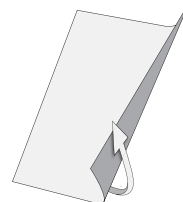

TN5108 - KN5108 SPECIFIKUS BUKÓCSŐ

BMW R1200GS (2013)

N°	Megnevezés	Méret	Kód	Mennyiség	
10	Alátét	Ø10	10RON	6	
11	Alátét	Ø8	8RON	8	
12	Anya	M8, karimás, önzáró	8DADIAFLN	6	

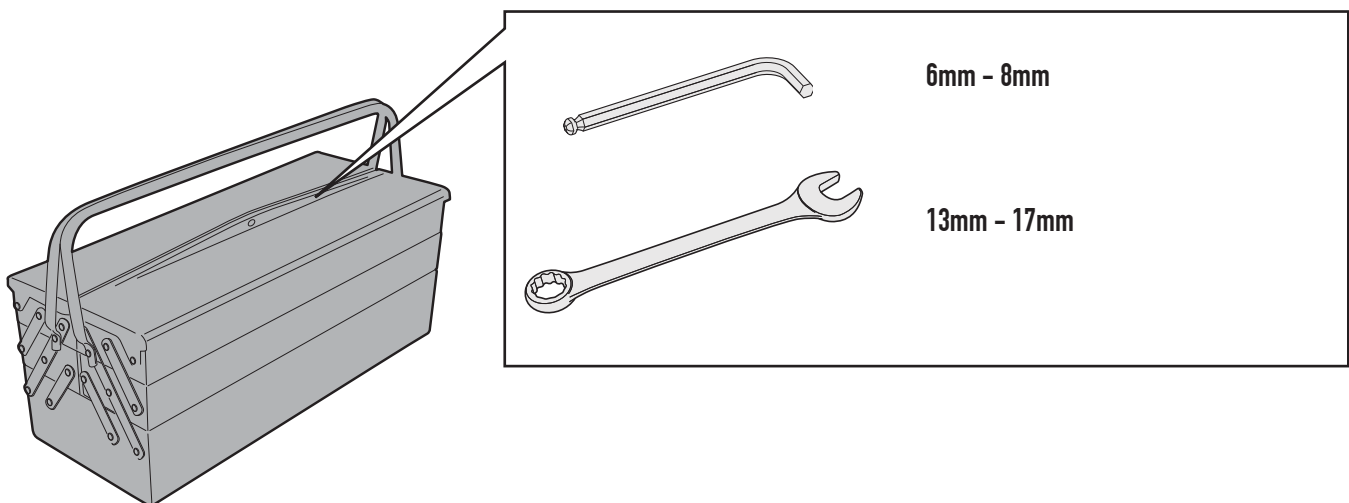

TN5108 - KN5108
SPECIFIKUS BUKÓCSŐ
BMW R1200GS (2013)

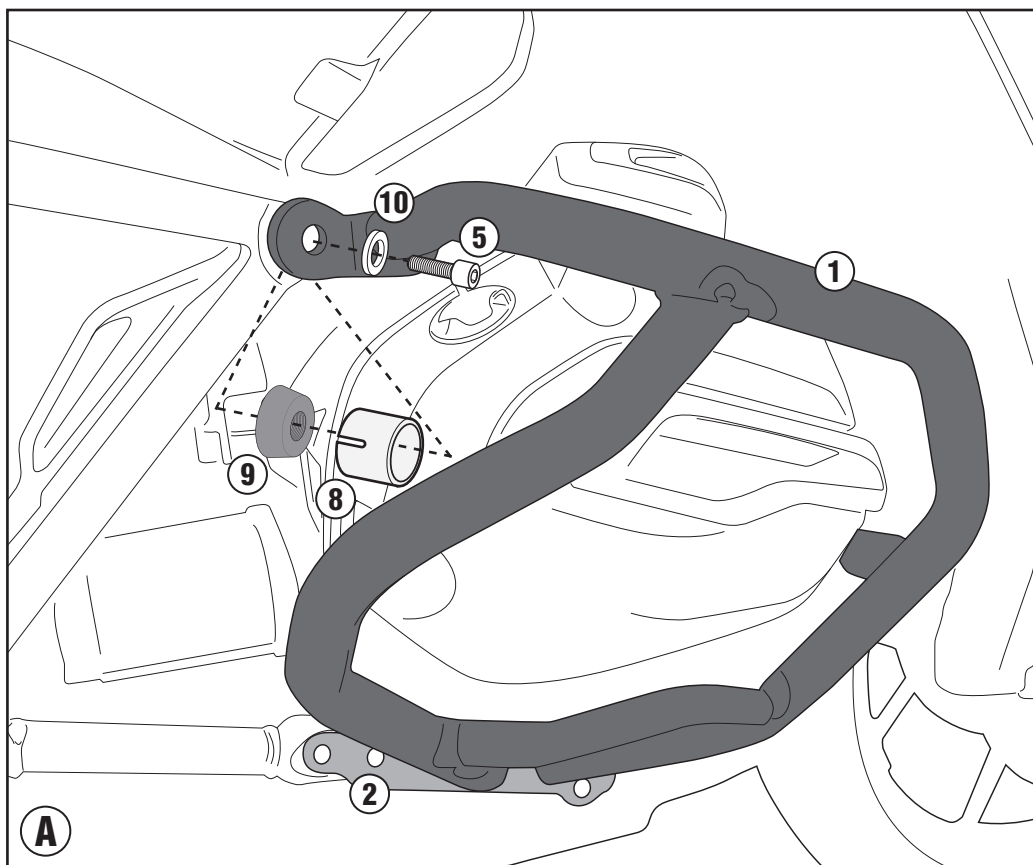
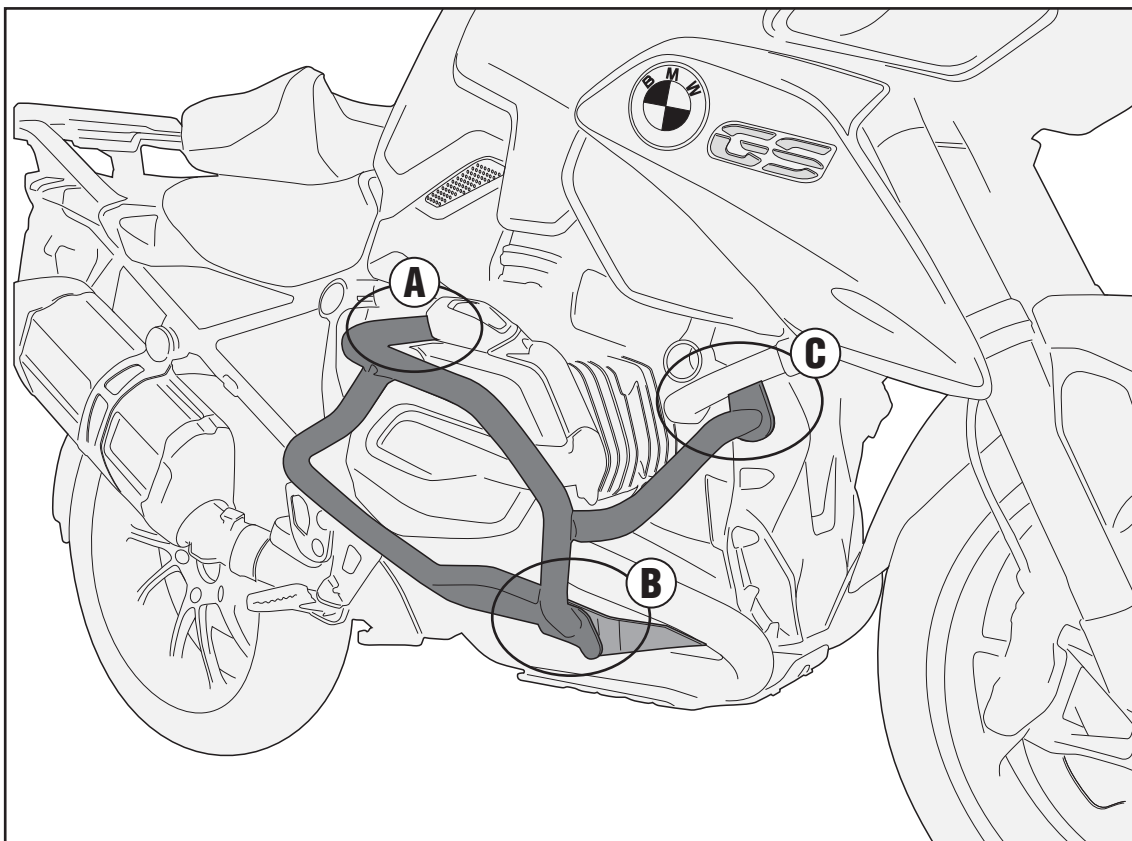

TN5108 - KN5108
SPECIFIKUS BUKÓCSŐ
BMW R1200GS (2013)

